

Small Drill 90° CHAM-BIT®

Cham-Bit Specifications for Small Fractional and Number Size Drills

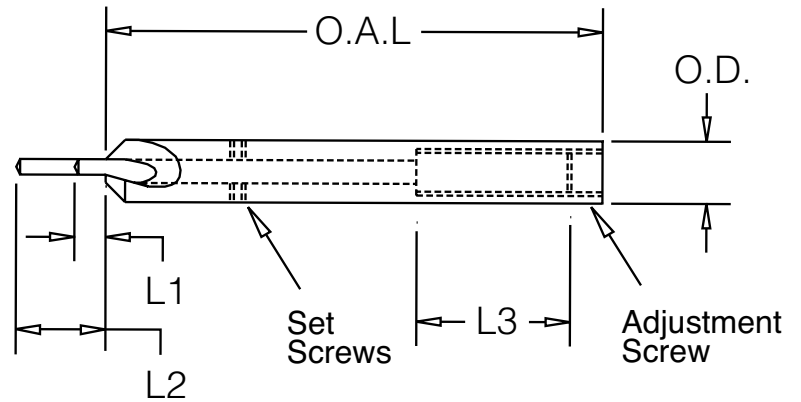

FRACTIONAL 90° SMALL DRILL CHAM-BIT Part Numbers and Dimensional Data

Part #	Item Description	OAL (in)	O.D. (in)	L1 Min (in)	L2 Max (in)	L3 Adj (in)	DRILL OAL (in)
MCC-MCC900625	1/16" 90° SM CHAM-BIT	1-3/4	1/4	1/4	7/8	5/8	1-7/8
MCC-MCC900781	5/64" 90° SM CHAM-BIT	1-7/8	1/4	1/4	7/8	5/8	2
MCC-MCC900938	3/32" 90° SM CHAM-BIT	2-1/8	1/4	1/4	7/8	5/8	2-1/4
MCC-MCC901094	7/64" 90° SM CHAM-BIT	2-1/2	1/4	1/4	7/8	5/8	2-5/8
MCC-MCC901250	1/8" 90° SM CHAM-BIT	2-5/8	1/4	1/4	7/8	5/8	2-3/4

NUMBER, 90° SMALL DRILL CHAM-BIT Part Numbers and Dimensional Data

Part #	Item Description	OAL (in)	O.D. (in)	L1 Min (in)	L2 Max (in)	L3 Adj (in)	Drill OAL (in)
MCC-MCC900635	#52 90° SM CHAM-BIT	1-3/4	1/4	1/4	7/8	5/8	1-7/8
MCC-MCC900670	#51 90° SM CHAM-BIT	1-7/8	1/4	1/4	7/8	5/8	2
MCC-MCC900700	#50 90° SM CHAM-BIT	1-7/8	1/4	1/4	7/8	5/8	2
MCC-MCC900730	#49 90° SM CHAM-BIT	1-7/8	1/4	1/4	7/8	5/8	2
MCC-MCC900760	#48 90° SM CHAM-BIT	1-7/8	1/4	1/4	7/8	5/8	2
MCC-MCC900785	#47 90° SM CHAM-BIT	1-7/8	1/4	1/4	7/8	5/8	2
MCC-MCC900810	#46 90° SM CHAM-BIT	2	1/4	1/4	7/8	5/8	2-1/8
MCC-MCC900820	#45 90° SM CHAM-BIT	2	1/4	1/4	7/8	5/8	2-1/8
MCC-MCC900860	#44 90° SM CHAM-BIT	2	1/4	1/4	7/8	5/8	2-1/8
MCC-MCC900890	#43 90° SM CHAM-BIT	2-1/8	1/4	1/4	7/8	5/8	2-1/4
MCC-MCC900935	#42 90° SM CHAM-BIT	2-1/8	1/4	1/4	7/8	5/8	2-1/4
MCC-MCC900960	#41 90° SM CHAM-BIT	2-1/4	1/4	1/4	7/8	5/8	2-3/8
MCC-MCC900980	#40 90° SM CHAM-BIT	2-1/4	1/4	1/4	7/8	5/8	2-3/8
MCC-MCC900995	#39 90° SM CHAM-BIT	2-1/4	1/4	1/4	7/8	5/8	2-3/8
MCC-MCC901015	#38 90° SM CHAM-BIT	2-3/8	1/4	1/4	7/8	5/8	2-1/2
MCC-MCC901040	#37 90° SM CHAM-BIT	2-3/8	1/4	1/4	7/8	5/8	2-1/2
MCC-MCC901065	#36 90° SM CHAM-BIT	2-3/8	1/4	1/4	7/8	5/8	2-1/2
MCC-MCC901100	#35 90° SM CHAM-BIT	2-1/2	1/4	1/4	7/8	5/8	2-5/8
MCC-MCC901110	#34 90° SM CHAM-BIT	2-1/2	1/4	1/4	7/8	5/8	2-5/8
MCC-MCC901130	#33 90° SM CHAM-BIT	2-1/2	1/4	1/4	7/8	5/8	2-5/8
MCC-MCC901160	#32 90° SM CHAM-BIT	2-5/8	1/4	1/4	7/8	5/8	2-3/4
MCC-MCC901200	#31 90° SM CHAM-BIT	2-5/8	1/4	1/4	7/8	5/8	2-3/4
MCC-MCC901285	#30 90° SM CHAM-BIT	2-5/8	1/4	1/4	7/8	5/8	2-3/4